

**MACROM**

MACROM SA. LUXEMBOURG, MENDRISO BRANCH  
3 MOREE ST., CH 6850 MENDRISO  
SWITZERLAND

# MACROM



**M1A.2250**

**Owner's Manual**

# Front/Rear view

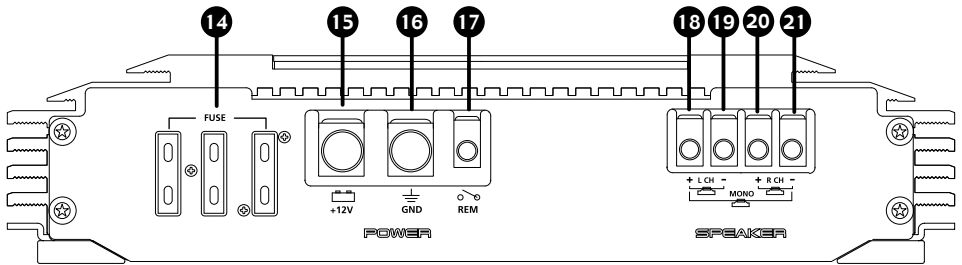
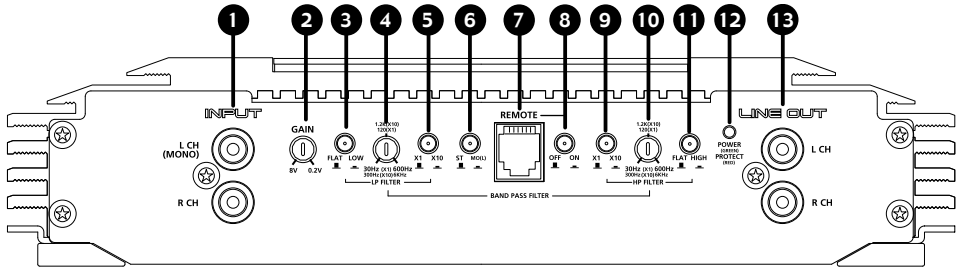

- |  |  |
|--|--|
| <ul style="list-style-type: none"> <li>❶ Low Level Input</li> <li>❷ Gain Control</li> <li>❸ Low pass switch</li> <li>❹ Low pass cutting adjustment</li> <li>❺ Multiplier x1/x10 switch for Low section</li> <li>❻ Stereo Mono input selector</li> <li>❼ EBC (External Bass Control)</li> <li>❽ EBC ON/OFF switch</li> <li>❾ Multiplier x1/x10 switch for High section</li> <li>❿ High pass cutting adjustment</li> <li>⓫ High pass switch</li> <li>⓬ Led indicator</li> <li>⓭ Line Output</li> </ul> | <ul style="list-style-type: none"> <li>❿ Fuse</li> <li>⓫ 12V (DC) power terminal</li> <li>⓬ Remote terminal</li> <li>⓭ GND terminal</li> <li>⓮ + Left channel terminal (+ MONO)</li> <li>⓯ - Left channel terminal</li> <li>⓰ + Right channel terminal</li> <li>⓱ - Right channel terminal (- MONO)</li> </ul> |
|--|--|

## Features

- **Two channel power amplifier**
- **250 watts into 2 ohms load**
- **125 watts into 4 ohms load**
- **High efficiency T03PL transistor on amplifier stage**
- **Variable 18/12dB/oct Low-High-Band pass x-over**
- **Multiplayer x10 Frequency cutting**
- **Adjustable x-over from 30Hz to 600Hz (x1) 300Hz to 6000Hz (x10)**
- **Stereo/Mono mode selector (ST/mono Out)**
- **EBC external bass control**
- **Pre-amplified Line output**
- **PWM Mos-Fet power supply**
- **20sq.mm power terminals**

## Technical data

RMS Power at 4 ohm Stereo load at 14,4 volts	125 x 2 watts
RMS Power at 2 ohm Stereo load at 14,4 volts	250 x 2 watts
RMS Power at 4 ohm Bridged load at 14,4 volts	500 x 1 watts
THD (total Harmonic Distortion)	< 0,1%
Frequency response (+0/-1 dB)	10 - 30,000Hz
Signal to noise ratio	> 100 dB
Low Input sensitivity	200-8,000mV
High Input sensitivity	1-10V
Input impedance	22k /100 ohm
Crossover type	Variable 18/12 dB/octave
Crossover frequency & filter slop (High-pass)	30 to 600Hz (x1) 300 to 6,000Hz (x10)
Crossover frequency & filter slop (Low-pass)	30 to 600Hz (x1) 300 to 6,000Hz (x10)
Line Output	1-1
Dimension (w * h * d) mm	250 x 55 x 360

DUE TO CONTINUING IMPROVMENT, THE FEATURES AND DESIGN ARE SUBJECT TO CHANGE WITHOUT NOTICE

# Crossover setting

- (Eng)** Select "FLAT" for a complete frequency range.  
**(FR)** Choisissez "FLAT" pour une gamme de fréquence de complete.  
**(IT)** Selezionare "FLAT" per una completa risposta in frequenza.  
**(D)** Wählen Sie "FLAT" für einen complete Frequenzbereich vor.  
**(SP)** Seleccione "FLAT" para una gama de frecuencia del complete.

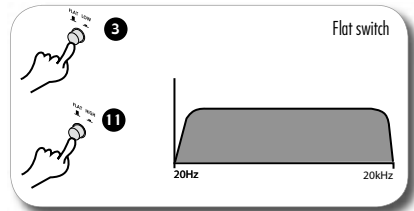

- (Eng)** Select "LOW" for a low frequency range.  
**(FR)** Choisissez l'"LOW" pour une gamme de basse fréquence.  
**(IT)** Selezionare "LOW" per la risposta delle frequenze basse.  
**(D)** Wählen Sie "LOW" für eine Niederfrequenzstrecke vor.  
**(SP)** Seleccione el "LOW" para una gama de la frecuencia baja.

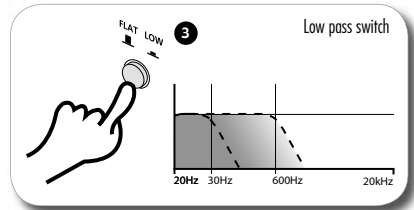

- (Eng)** Select "HIGH" for a high frequency range.  
**(FR)** Choisissez la "HIGH" pour une gamme à haute fréquence.  
**(IT)** Selezionare "HIGH" per la risposta delle frequenze alte.  
**(D)** Wählen Sie "HIGH" für eine Hochfrequenzstrecke vor.  
**(SP)** Seleccione el "HIGH" para una gama de alta frecuencia

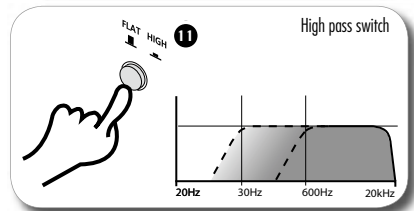

- (Eng)** Select "LOW and High" for a band pass frequency range.  
**(FR)** "LOW et HIGH" choisis pour une gamme de fréquence de passage de bande.  
**(IT)** Selezionare "LOW e HIGH" per la risposta passa banda.  
**(D)** Wählen Sie "LOW" für eine Niederfrequenzstrecke vor.  
**(SP)** "LOW y HIGH selectos" para una gama de frecuencia del paso de la venda.

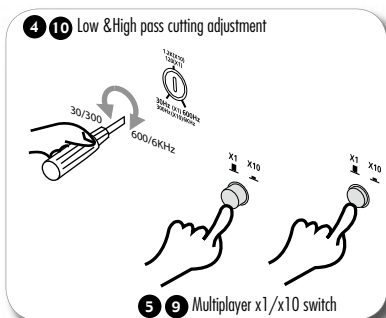
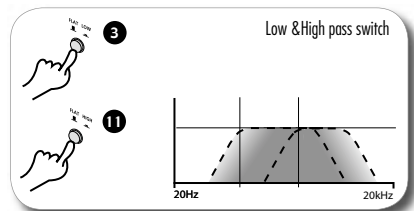

**(Eng)** The cut frequency is selectable between 30 to 600 Hz with Multiplayer "X1" and 300 to 6000Hz with multiplier "X10"

**(FR)** La fréquence de coupe est sélectionnable entre 30 à 600 hertz avec "X1" multi-joueur et 300 à 6000Hz avec le multiplicateur "X10".

**(IT)** La frequenza di taglio è selezionabile fra 30 a 600 Hz con moltiplicatore "X1" e 300 a 6000 Hz con moltiplicatore "X10"

**(D)** Die Schnittfrequenz ist zwischen 30 bis 600 Hz mit Multiplayer "X1" und 300 zu 6000Hz mit Vervielfacher "X10" auswählbar

**(SP)** La frecuencia del corte es seleccionable entre 30 a 600 hertzios con "X1" multi-player" y 300 a 6000Hz con el multiplicador "X10"

# Speakers connection

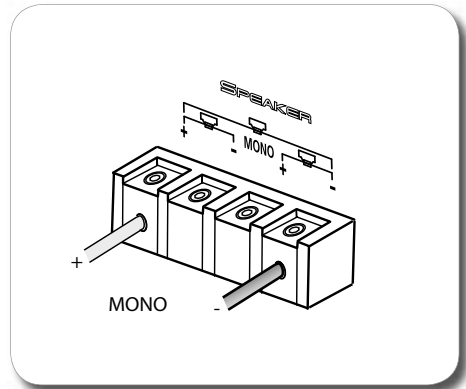
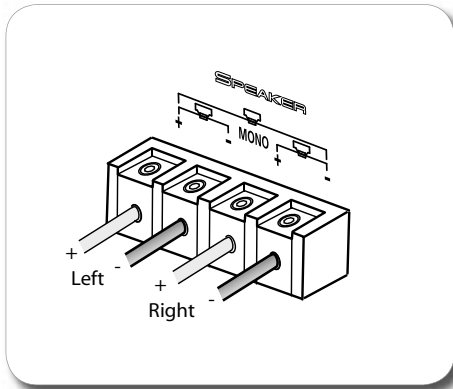

**(Eng)** Minimal acceptable Impedance 2 ohm. To adhere itself to the illustrations for the connections.

**(FR)** Impédance acceptable minimale 2 ohms. Pour s'adhérer aux illustrations pour les raccordements.

**(IT)** Minima Impedenza accettabile 2 ohm. Attenersi alle illustrazioni per i collegamenti

**(D)** Minimaler annehmbarer Widerstand 2 Ohm. Sich die Abbildungen für die Anschlüsse befolgen.

**(SP)** Impedancia aceptable mínima 2 ohmios. Para adherirse a las ilustraciones para las conexiones.

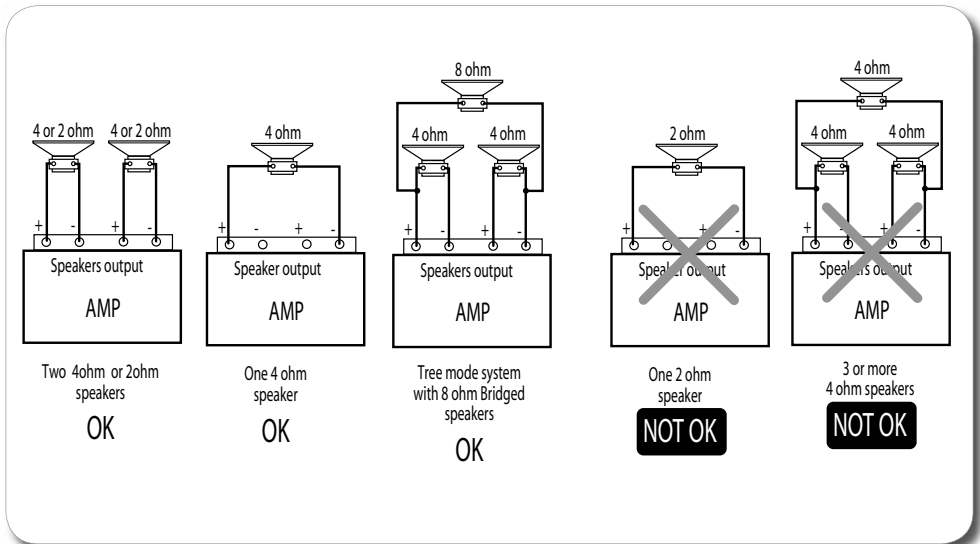

## Power connection

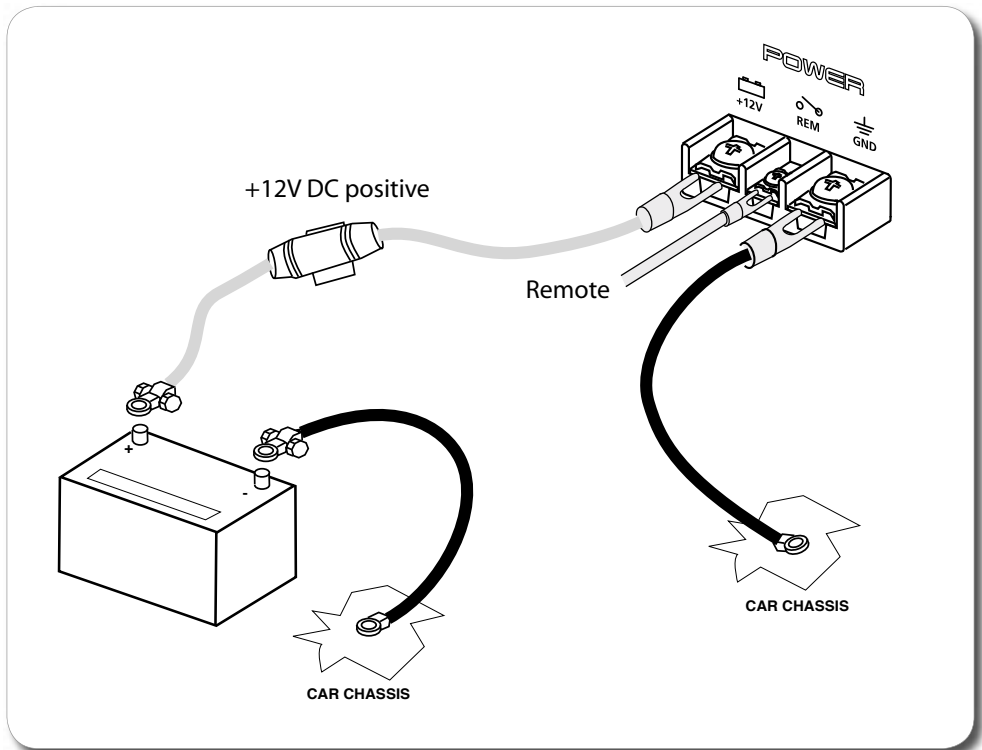

**(Eng)** Connect the Positive (+12V) directly to the Battery of the car. To make sure itself to insert a fuse of adequate amperage in order protect the system. Connect the Ground in to the car chassis, close as possible to the amplifier.

**(FR)** Reliez le positif (+12V) directement à la batterie de la voiture. Pour s'assurer soi-même pour insérer un fusible d'ampérage proportionné dans l'ordre protégez le système.  
Reliez le négatif dedans au châssis de voiture, fin comme possible à l'amplificateur.

**(IT)** Collegare il Positivo (+)  
Collegare il Negativo al telaio dell'automobile, più vicino possibile all'amplificatore.

**(D)** Schließen Sie das Positiv (+12V) direkt an die Batterie des Autos an. Um sicherzustellen selbst zum einer Sicherung der ausreichenden Stromstärke im Auftrag einzusetzen schützen Sie das System.  
Schließen Sie das Negativ innen an das Autochassis an, Ende, wie möglich zum Verstärker.

**(SP)** Conecte el positivo (+12V) directamente con la batería del coche. Para cerciorarse de sí mismo para insertar un fusible del amperaje adecuado en orden proteja el sistema.  
Conecte la negativa adentro con el chasis del coche, cierre como sea posible al amplificador.

## Input setting

### 1 Low Level Input

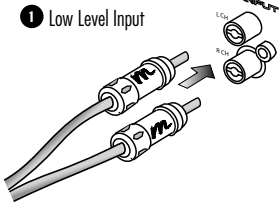

**(Eng)** Connect the output Audio coming from the car radio, in to the Low level input of the amplifier.

**(FR)** Relier l'output Audio provenant de l'autoradio, au input Low level de l'amplificateur.

**(IT)** Collegare l'uscita Audio proveniente dall'autoradio, all'ingresso Low level dell'amplificatore.

**(D)** Das Ausgang Audiokommen von vom Autoradio anschließen, das niedrige Niveau des Verstärkers einzugeben.

**(SP)** Para conectar venir audio de la salida de la radio de coche, entrar el nivel bajo del amplificador.

**(Eng)** Adjust the gain control, according to the Audio level output.

**(FR)** Ajustez la commande de gain, selon le rendement de niveau audio.

**(IT)** Regolare il controllo di guadagno, in funzione del segnale Audio in uscita.

**(D)** Justieren Sie die Gewinnsteuerung, entsprechend dem waagrecht ausgerichteten Audioausgang.

**(SP)** Ajuste el control del aumento, según la salida llana audio.

### 2 Gain Control

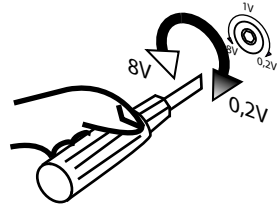

**(Eng)** Select ST or Mono Input in agreement to the type of wished configuration. In the case of the configuration mono, use the L (mono) input.

**(FR)** Choisissez la rue ou l'entrée mono d'accord au type de configuration souhaitée. Dans le cas de la configuration mono, employez l'entrée de L (mono).

**(IT)** Selezionare ST o Mono Input in accordo al tipo di configurazione desiderata. Nel caso della configurazione mono, utilizzare l'ingresso L (mono).

**(D)** Wählen Sie Str. oder Monoeingang in der Vereinbarung zur Art der gewünschten Konfiguration vor. Im Fall von der Mono Konfiguration, benutzen Sie den L (mono) Eingang.

**(SP)** Seleccione el ST o la mono entrada en el acuerdo al tipo de configuración deseada. En el caso de la configuración mono, utilice la entrada de L (mono).

### 6 ST/Mono Selector

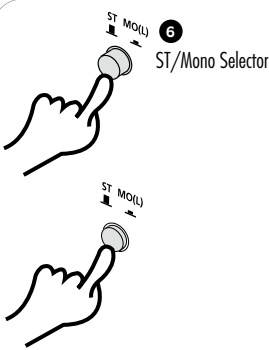

### 7 EBC (External Bass Control)

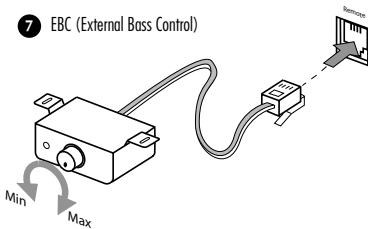

**(Eng)** Through control Remote EBC, it is possible to control the level of the Volume of the amplifier. Placed control EBC in the front part of the vehicle.

**(FR)** Par la commande EBC à distance, il est possible de commander le niveau du volume de l'amplificateur. Commande placée EBC dans la partie avant du véhicule.

**(IT)** Tramite il controllo Remote EBC, è possibile controllare il livello del Volume dell'amplificatore. Collocare il controllo EBC nella parte anteriore del veicolo.

**(D)** Durch Steuerung Remote-EBC, ist es möglich, das Niveau des Volumens des Verstärkers zu steuern. Gesetzte Steuerung EBC im Vorderteil des Trägers.

**(SP)** Con el control EBC alejado, es posible controlar el nivel del volumen del amplificador. Control puesto EBC en la parte delantera del vehículo.